

# Spirule Instructions

by

WALTER R. EVANS

## Contents

- \* 1 Symbols, Glossary, References
  - \* 2 Root-Locus Fundamentals
  - \* 3 Sketch Aids: Real Axis, Asymptotes, Quadratics
  - \* 4 Root-Loci Properties: Constant Sum, Conformal Map
  - \* 5 Addition of Angles (Arm Rotation from Disk)
  - \* 6 Multiplication of Lengths: Scale Factor Correction
  - \* 7 Slide Rule Usage, 'Db' Conversion
  - #10 Bode Plots:  $(1 + Ts) = 1$  or  $Ts$ ,  $90^\circ$  over two decades
  - 11 Correction for Bode Plots: **M** and **P** Curves  $(1 + Ts)$
  - 9 Addition of Ordinates: **A+** and **A-** Curves
  - 8 Quadratic Curves: Log Amp. and Phase vs. Log  $w$
  - \* 12 Other Curves and Scales:  $S/2$ ,  $1/S$ , Damping Ratio
  - \* 13 Closed Loop Function: Locus Vs. Almost Anything
  - 14 Nichols' Chart: Closed Loop from Bode Data
  - 15 Right Triangle Solution: Vector Sum
  - 16 "Trig-graph":  $\log \tan \theta$  and  $\log \sec \theta$  vs  $\theta$
- \* Applicable to root-locus  
# Suggested order of reading. (Page order is shifted to permit figures to be seen when reading associated text.)

## Symbols

<b>f</b> freq (cycles/sec)	<b>G</b> Forward Function
<b>q</b> zero	<b>H</b> Feedback Function
<b>p</b> pole	<b>K</b> Loop Gain
<b>r</b> root	<b>P</b> No. of Poles
<b>s</b> Laplace variable	<b>Q</b> No. of Zeros
<b>w</b> freq (rad/sec)	<b>T</b> Time Constant

(1) Reference number for text and figures

## Glossary

**SP** (Starting Position) — The **R** line is at  $0^\circ$  on the disk which also puts the  $x1$  arrow of disk at 1 on arm scale.

**Fix Disk** — Press disk against plot with the right index finger; motion of arm then changes readings between arm and disk. Otherwise the disk is free.

**Bode Plot** — Plot of log mag. and phase vs. log  $w$ .

**Nichols' Chart** — Conversion chart from open loop to closed loop using log mag. and phase.

**Break Frequency**: The frequency at which the straight line asymptotes on the Bode plot change slope.

**Quadratic**: A function of the form  $1 + 2bs/w + s^2/w^2$ , which arises for any system having energy interchange such as kinetic and potential in a spring-mass system.

**Vector**: A complex number identified by its magnitude and angle for convenience in taking products.

**Damping Ratio**: The ratio of the real part of the root to its magnitude. It is thus a measure of the decay rate per cycle of natural oscillation.

## References

- W. R. Evans — "Control System Dynamics," McGraw Hill, 1954
- J. G. Truxal — "Control System Synthesis," McGraw Hill, 1955
- C. H. Wilts — "Principles of Feedback Control," Addison-Wesley, 1960

Copyright 1965: The Spirule Company  
9728 El Venado Drive  
Whittier, California 90603, U.S.A.

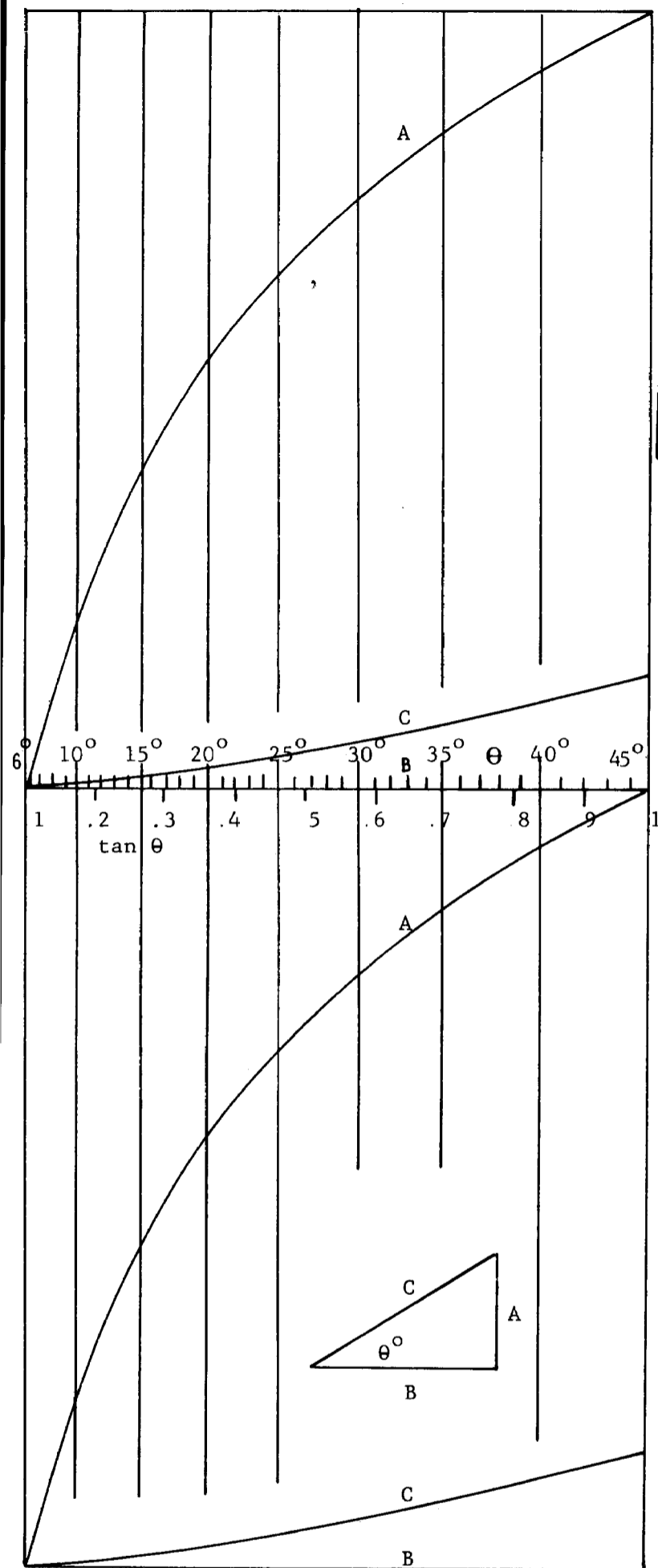

ROOT-LOCUS FUNDAMENTALS

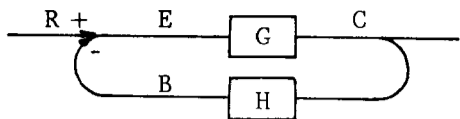

Characteristic Equation:  $R = 0$ , or  $E = -B$

Thus,  $(B/E) = GH$  must  $= -1 = 1 / \underline{180^\circ}$

Typically  $GH = \frac{K'(s-q)}{s^2(s-p)}$

Root-Locus

$2\theta + \theta_1 - \phi_1 = 180^\circ$

$K' = \frac{|s|^2 |s-p|}{|s-q|}$

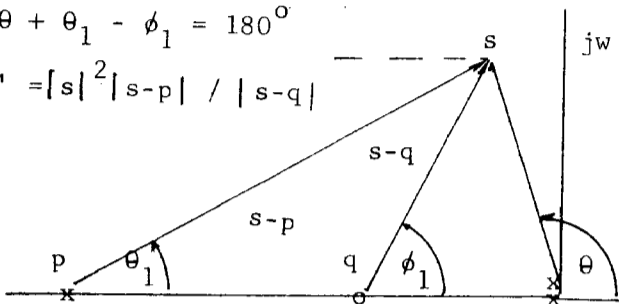

Poles and zeros of the  $GH$  function determine locus of roots of  $GH = -1$  as  $K'$  is increased from 0 to infinity.

A sketch of root-locus is made first using special intervals (p. 3). In the region of interest, a trial  $s$  point is chosen and the net angle is measured with the Spirule. The locus is then interpolated between trial points. For a desired root along the locus, gain is computed as product of vector lengths (p. 6).

For cases in which  $s$  covers more than 10/1 range, a "ballpark" plot determines phase shift pattern in the "infield" due to "outfield" poles.

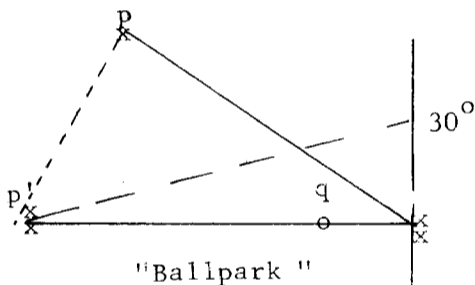

"Ballpark"

The pole  $p'$  produces the same phase shift at low  $w$  as  $p$  or  $p^*$ .

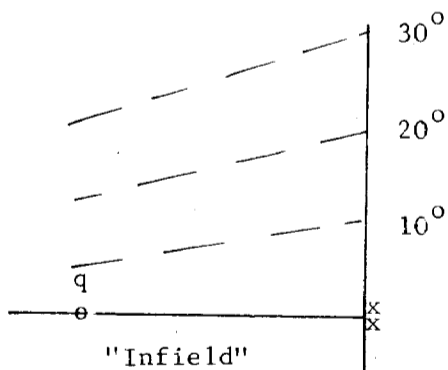

"Infield"

SKETCH AIDS FOR ROOT-LOCUS PLOTS

$\frac{K'}{s(s-p_1)(s-p_2)} = -1$

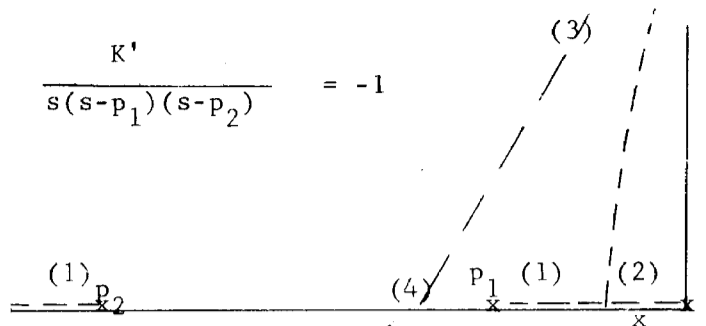

- (1) **Real Axis Intervals** — The real axis intervals occur wherever the total number of zeros and poles which lie to the right is odd.
- (2) **Breakaway Point:**  $1/x = 1/(x-p_1) + 1/(x-p_2)$
- (3) **Asymptotes:**  $(180^\circ + n360^\circ)/(P-Q)$
- (4) **Centroid of Asymptotes:**  
 $C = (\text{Sum of } p - \text{Sum of } q)/(P-Q)$
- 5) **Symmetry about the real axis** exists for conjugate zeros and poles and real gain values.
- 6) Roots move from poles to asymptotes or zeros as gain  $K'$  increases from zero to  $\infty$ .

Quadratic

$\frac{K'(s-q)}{s^2} = -1$

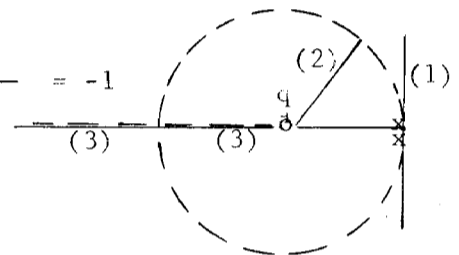

- (1) The locus breaks away from double pole at  $90^\circ$ .
- (2) The locus is circle about zero  $q$  as center.
- (3) The locus approaches  $q$  or  $-\infty$  as  $K'$  increases.

Initial Direction From Complex Pole or Zero

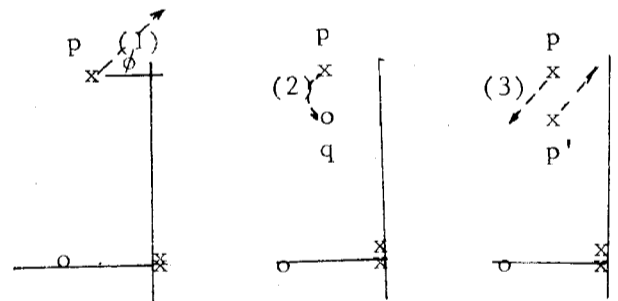

- (1) Select  $p$  to be the trial  $s$  point. Find sum of angles for all other zeros and poles; then make the angle  $\phi$  from pole bring the total angle to  $180^\circ$ .
- (2) A zero  $q$  close to  $p$  makes a circle arc locus between  $p$  and  $q$ .
- (3) A pole  $p'$  reverses the  $p$  branch, but its branch starts along original  $p$  branch direction.

## PROPERTIES OF ROOT-LOCI

### Centroid of Roots Constant

For a transfer function having  $P-Q \geq 2$ , the vector sum of the roots is constant.

### Substitution of Poles for Roots

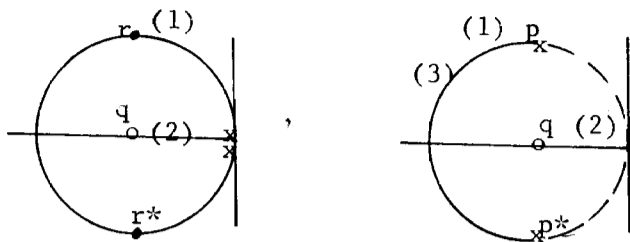

- (1) Replace roots at given  $K_1$  with new poles  $p$  and  $p^*$ .
- (2) Retain zero  $q$ ; continue locus along original path.
- (3) The gain in new plot is the increase  $\Delta K$  over  $K_1$ .

### Nearly Equal Roots

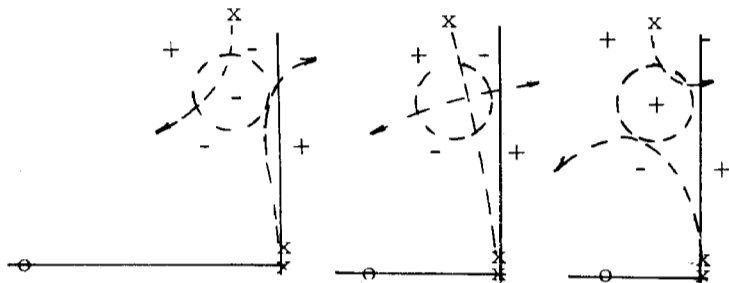

"Right Turn"      "Loci Meet"      "Left Turn"

Angle sums in the dotted circle area are all nearly  $180^\circ$ . A slight shift of the zero will change the "loci meet" plot to the "left turn" or "right turn" plot. Measure the angle near center of circle; if  $-$  deviation from  $180^\circ$ , a right turn plot results. If  $+$  deviation, a left turn.

Neither transient response nor frequency response is critical to the choice of root locations in such cases if the roots are not close to the  $j$  axis.

### Force Analogy

The locus is in direction of net vector force acting on a particle which is repelled from poles and attracted to zeros inversely proportional to distance.

### Conformal Mapping

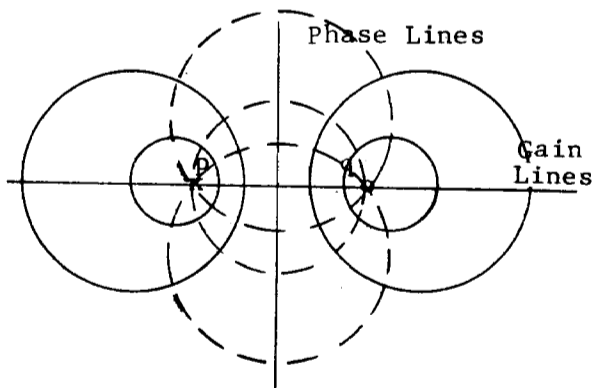

## ADDITION OF ANGLES

### Starting Position

### After First Angle

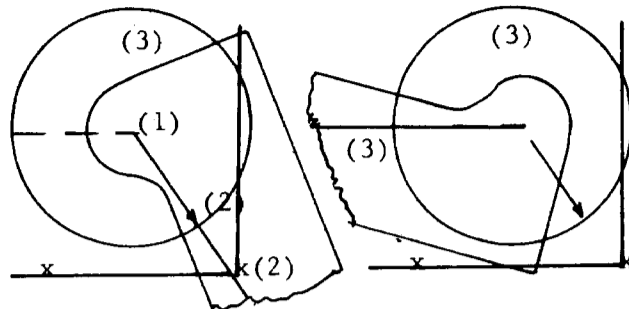

- (1) Center pivot at trial  $s$  point; fix it with right thumb.
- (2) With disk at  $SP$ , align  $R$  with pole at origin.
- (3) Fix disk while rotating  $R$  to the horizontal.
- (4) Release disk; repeat rotations for other poles.
- (5) Read angle of disk at the  $R$  line.
- (6) Mark error on plot ( $5^\circ$  for  $185^\circ$  reading).
- (7) Interpolate locus between marked points.

### Reverse Rotation for Zeros

For a zero, fix disk while rotating  $R$  from horizontal to the zero. For net angle of zero and pole, fix disk while rotating  $R$  from pole to zero.

### Change in Angle Sum for Change in Trial $s$ Point

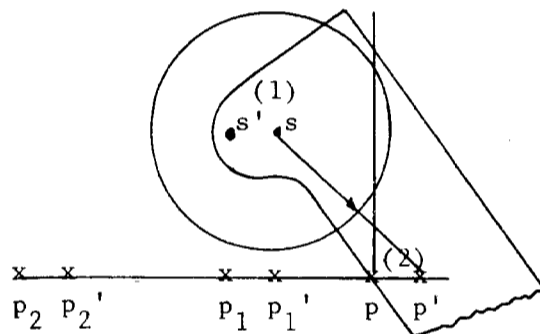

- (1) A new trial  $s$  point at  $s'$  involves small angle changes from previously measured values.
- (2) Leave pivot at  $s$ , but consider all poles to be shifted 1 square of graph paper to the right as marked by primed poles.
- (3) Fix disk while rotating arm from  $p'$  to  $p$  for all poles. For zeros, rotate from  $q$  to  $q'$ .
- (4) Read net angle change equivalent to pivot at  $s'$  instead of  $s$ .
- (5) Add change to previous value marked at  $s$  and mark the new value at  $s'$ .

### Breakaway Point from Real Axis

Select point just above real axis and carry out rotations in the usual way.

### Option

Use  $j\omega$  axis rather than a horizontal line when convenient. Angle reading for point on locus should then be  $(P-Q-2) 90^\circ$ .

### MULTIPLICATION OF LENGTHS

Starting Position

After First Pole

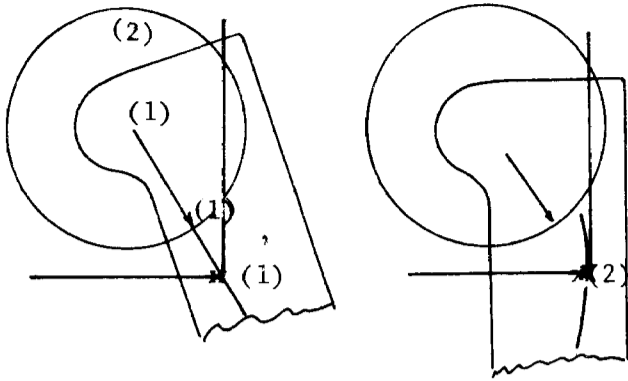

- (1) Center the pivot at *s* point, set disk at SP, aline *R* with the pole at the origin.
- (2) Fix disk while rotating arm until *S* is on pole.
- (3) Release disk, repeat steps (1), (2) for other poles.
- (4) For zeros, fix disk while rotating from *S* to *R*.
- (5) Read product on the arm scale at the disk arrow. (Reading of .4 with x.1 arrow means .04.)
- (6) Scale factor correction (next section) is carried out before above operations at *s* point.

#### Scale Factor Correction

$$\frac{K' (s+5)}{s (s+10) (s+30)} = -1$$

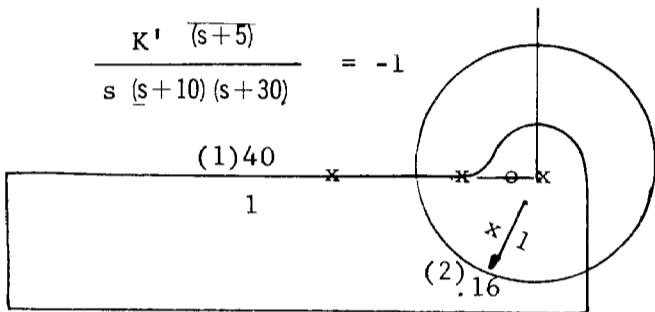

- (1) Read plot value  $L_1 = 40$  at unity (5'') on Spirule.
- (2) Note  $P - Q = 2$ ; therefore correction  $(L_1)^{P-Q} = 1600$ . Set .16 at x1 arrow. (.16 is the same as 1600, 1 revolution = 10,000.)
- (3) Put a pencil mark on the disk at edge of arm to record starting point for any subsequent *s* point.
- (4) Shift to trial *s* point and carry out usual rotations starting from the marked position of disk.
- (5) Read  $K'$  on arm scale already corrected.

$$\frac{K(1+s/5)}{s(1+s/10)(1+s/30)} = -1$$

$$K = \frac{s(s+10)(s+30)}{(s+5)} \frac{5}{10 \cdot 30}$$

The correction can be made by multiplying by 1600 as before and then by  $5/10 \cdot 30$ .  $K$  is the value of gain usually used, not  $K'$  as in the previous form.

An alternate procedure bypasses the scale factor correction for all points except pole at the origin.

- (1) Place the pivot at the origin and rotate for *R* to *S* for poles at 10 and 30, and from *S* to *R* for the zero at 5.
- (2) Read angle on disk and set the negative angle. (Read  $15^\circ$  and set  $345^\circ$  in this case.)
- (3) Multiply by 40 and mark disk at edge of arm.
- (4) Shift pivot to trial *s* point, rotate as usual, read  $K$  on arm scale already corrected.

### USE AS A SLIDE RULE

Example:  $.4 \times .3 \times .2$

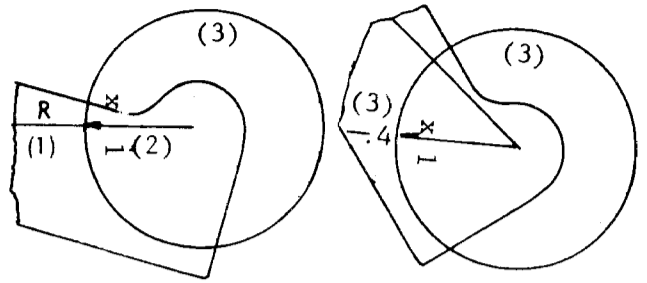

- (1) Draw straight line to serve as a crosshair.
- (2) With disk at SP, and *R* on the line, fix pivot.
- (3) Fix disk while rotating arm until .4 is on line.
- (4) Release disk and return *R* to the line.
- (5) Repeat steps (3) and (4) for .3 and .2.
- (6) Read .24 at x.1 arrow giving .024 as the result.

Example:  $800 \times .3 / .4 = .8 \times .3 / .4 \times 10^3$

- 1) Carry out steps 1-4 for .8 and .3.
- 2) With the disk free, aline .4 on the crosshair.
- 3) Fix disk while rotating arm until *R* is on the line.
- 4) Read result of .6 at x1 arrow  $\times 10^3 = 600$ .

Option: The net result of the ratio  $.3/.4$  can be obtained by fixing disk while rotating arm from .4 on the line to .3 on the line.

Option:  $800 \cdot .3 / .4 = 83/4 \times 10^2$

The steps are the same as above except  $R'$  is used instead of *R*. Ignore the decimal points on arm scale, treating the scale as 1 to 10 instead of .1 to 1.

#### "Db" Conversion

Set the x10 arrow on number on arm scale, read log value on disk at *R* line (again ignoring decimal point), and multiply log by 20 for "Db" value. Divide "Db" by 20, set it on log scale, and read value on arm scale.

#### Approximation for $(1+x)^n$

$$\log_{10} (1+x)^n = n (\log_{10} e) \log (1+x) = n(1/2.3) (x)$$

$$N = (1.03)^{20}; \log_{10} N = 20(.03)/2.3 = .26; N = 1.85$$

$$\text{Actually } \log (1+x) = x - 1/2(x)^2 + (1/3)x^3 - \dots$$

$$N = (1.1)^{10}; \log_{10} N = (.1 - .005)/2.3 = .414; N = 2.6$$

#### Mental Log Scale

N	1.25	2.0	3.2	5.0	8.0
		1.6	2.5	4.0	6.4
$\log_{10} N$	.1	.2	.3	.4	.5
		.6	.7	.8	.9
					1

# QUADRATIC CURVES

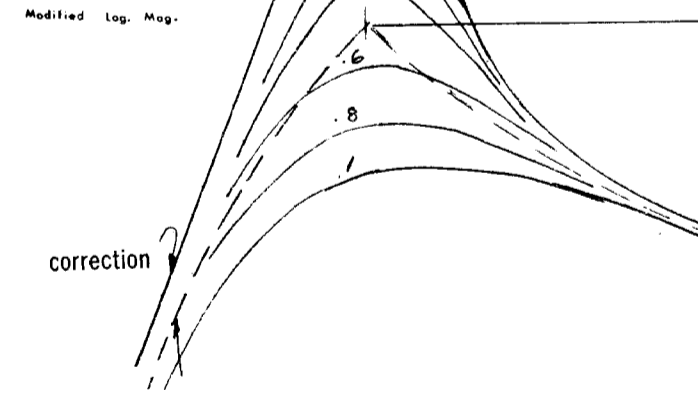
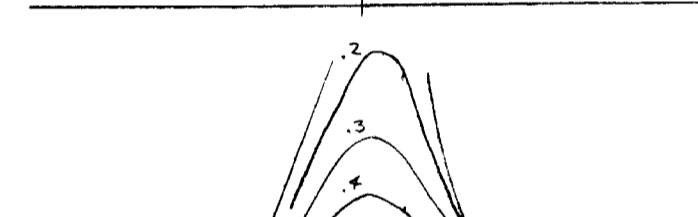
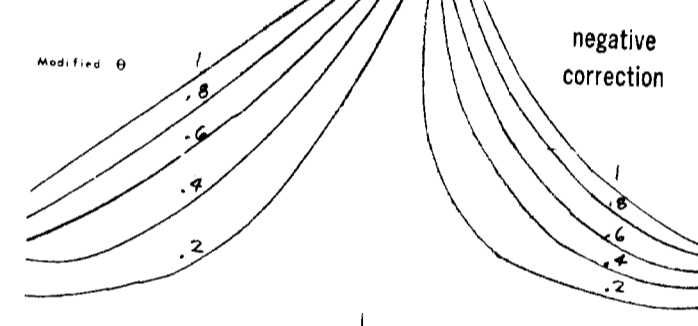
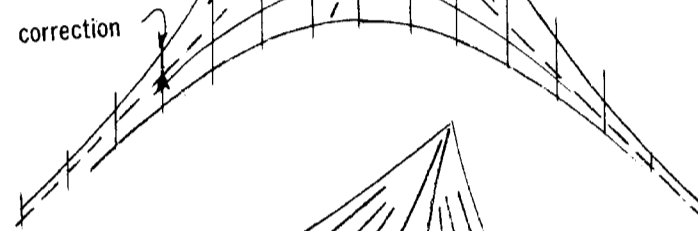
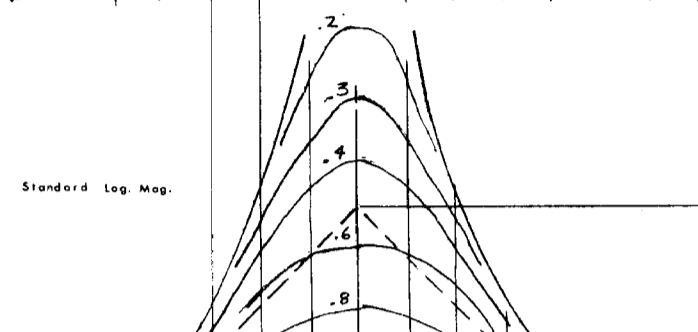
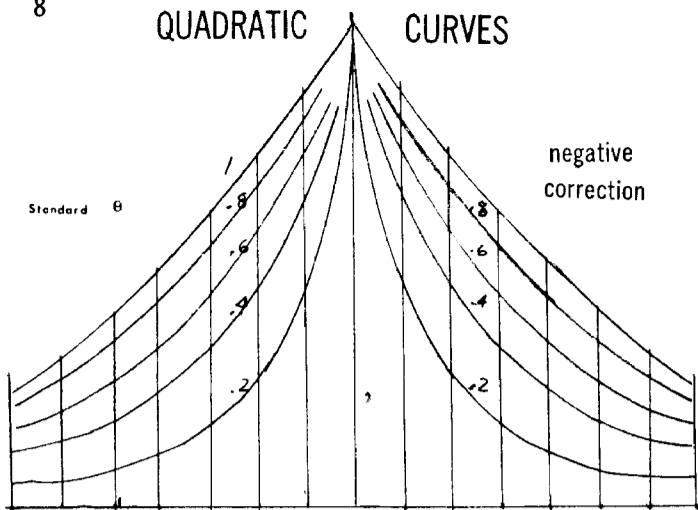

# ADDITION OF ORDINATES

## Option for Quadratic Correction (No Tracing)

1) Mark poles and zeros on the frosted plastic strip enclosed. (Mark damping ratio at each.)

(2) Fix strip on this line with  $w$  to be checked at

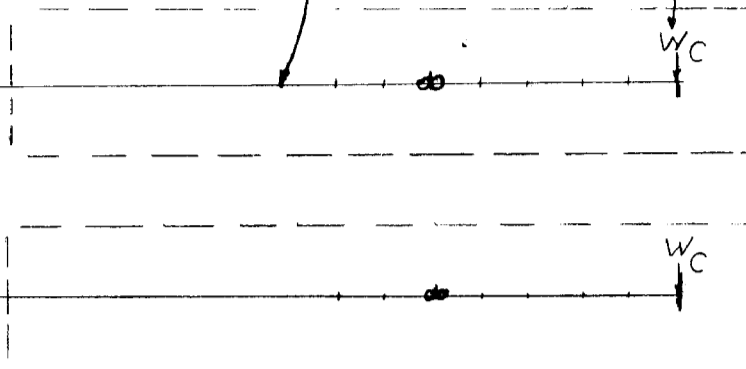

3) Shift pivot to the zero; fix disk while rotating  $A+$  curve from the ordinate for the  $q$  quadratic back to the base line.

4) Shift pivot to pole; fix disk while rotating  $A+$  curve to ordinate of curve for the  $p$  quadratic.

5) Read net correction on disk as before ( $10^\circ = 1''$ ).

## Modified Quadratic Curves

1) Mark poles and zeros on the frosted plastic strip enclosed. (Mark damping ratio at each.)

(2) Fix strip on arm along  $R$  line with  $w$  to be checked at the apex of the  $A+$ ,  $A-$  curves.

(3) Aline Spirule with pivot here

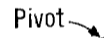

4) Fix disk while rotating arm until a pole is on the correction curve for its damping ratio.

5) For a zero, fix disk while rotating  $q$  from a curve to base line.



6) Read angle on disk at  $R$  line.

7) Plot correction using .2 on radial scale as  $10^\circ$  of disk reading.

8) Repeat steps 2-7 for enough points to determine the curve of the transfer function.

BODE PLOTS

Approximation of  $1 + j\omega T$

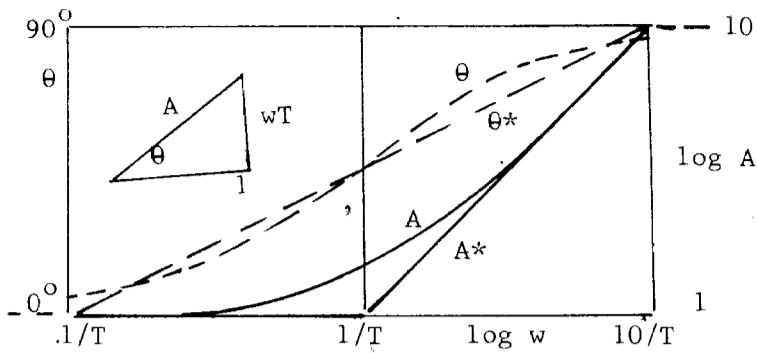

$A^*$  (approximation) = 1 for  $\omega T < 1$ , =  $\omega T$  for  $\omega T > 1$   
 $\theta^*$  (approximation) =  $45^\circ (1 + \log_{10} \omega T)$  for  $.1 < \omega T < 10$

Example Using  $(1 + Ts)$  Approximations

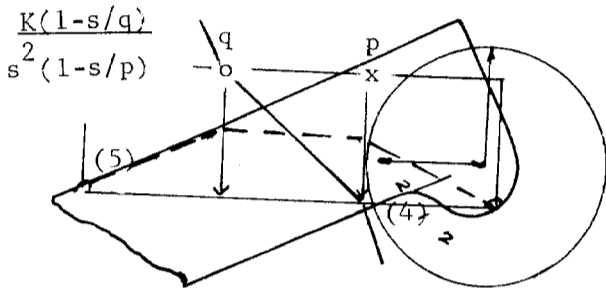

- (1) Mark the zeros and poles along the log  $w$  axis.
- (2) Mark half-zero and half-pole points on a parallel axis to denote break points for angle plot.
- (3) Draw straight line plots starting from known ordinate at left and working to the right using proper slopes between break frequencies.
- (4) For the  $1/2$  slope, set edge of arm at 2 on scale as shown; the other 2 is for a slope of 2.
- (5) Hold a pencil at starting point to serve as pivot.
- (6) Pivot arm about pencil until arrows on disk are square with plot. Draw line along edge to next break.

Quadratic Example:

$$\frac{K(1-s/p)(1-s/q^*)}{s(1-s/p)(1-s/p^*)}$$

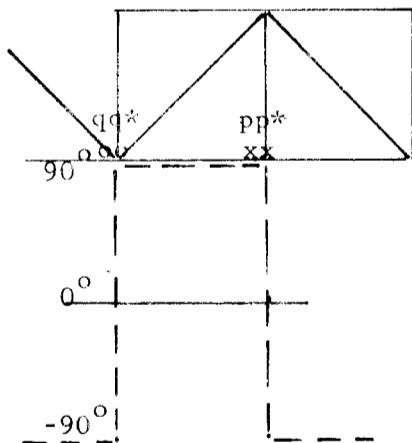

CORRECTION TO  $(1 + Ts)$  BODE PLOTS

Magnitude (M Curve)

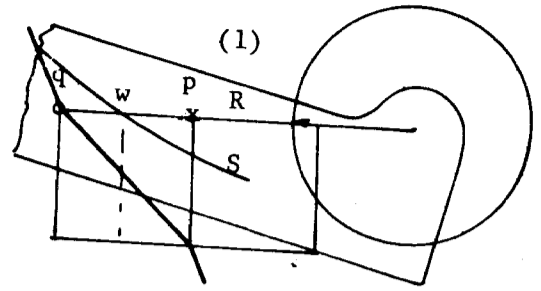

- (1) With disk at SP, RS intersection at the frequency  $w$  being checked, and R horizontal, fix pivot as shown.

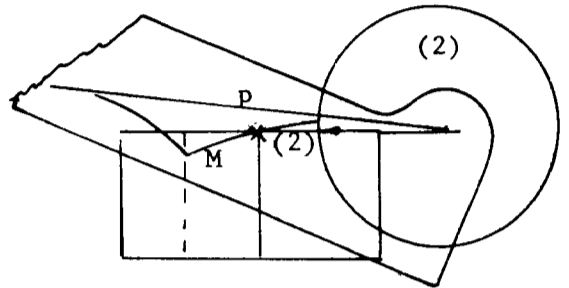

- (2) Fix disk while rotating M curve to pole.
- (3) Aline M with q, then fix disk while returning to level. The option, for net angle of q and p, is to fix disk while rotating M curve q to p.
- (4) Read the correction on arm scale at x1 arrow.
- (5) Plot correction from the straight line plot using  $2\frac{1}{2}$ " log scale on edge of Spirule.

Angle Correction (P Curve)

- 1-4) Same as for Magnitude section except P curve is used instead of M curve.
- 5) Read the correction angle on disk at R line.
- 6) Plot correction from the Bode plot using the angle scale at the end of the arm.

Quadratic Correction

The curves on p. 8 and the instructions on p. 9 are an evolution from tracing templates and adding ordinates to the equivalent of M and P curves for quadratics. Instructions on p. 8 are limited to details of placement of curves and Spirule. Two possibilities are described, but the latter is recommended as the most efficient.

The modified curves gives the correction as an angle as a function of log w separations between the frequency being checked w, and the poles or zeros.

## OTHER CURVES AND SCALES

### Logarithmic Spiral Curve, $\theta/90 = \log_{10} A/5''$

The angle between **R** and **S** varies as the log of the length **A** to the **S** curve. A  $90^\circ$  change corresponds to a length ratio of 1/10, unity is  $5''$  for  $\theta = 0^\circ$ .

The scale factor correction makes the results independent of the scale of the graph paper used.

**1/S** is a reflection of the **S** curved about the edge. If the edge is used as a reference instead of **R**, fix disk while rotating from **1/S** to edge to get same angle and sense as from edge to missing curve.

**S/2** has 1/2 the angle from **R** as the missing part of the **S** curve. Rotate twice between **R** and **S/2**.

### Damping Ratio Scale

Fix the pivot at origin with  $180^\circ$  of the disk along the negative real axis of the plot. Align the edge of the arm at the damping ratio desired and draw a line on the plot as possible criterion for root location along a locus.

### Scale of Graph Paper

A quadrille tablet with 4 lines to the inch is the intended paper for plots. This paper gives 10 lines in the  $2\frac{1}{2}''$  width of the Spirule arm. Such tablets are widely available and relatively inexpensive.

### Additional Curves

The purpose of any curve is to convert any quantity of interest to an angle. Apply frosted mending tape to the arm to permit any additional curves to be added in pencil. (The given curves are printed on the middle layer of laminated plastic.)

The disk may slip with respect to the arm when working on a soft pad of paper. Work on a single sheet on a hard surface or return Spirule for a free adjustment.

The handle has been added for easier control of the arm and shorter hand motions.

### Accuracy

**Angle:** The protractor scale is accurate despite the apparent eccentricity suggested by index lines being longer on the  $180^\circ$  side than on the  $0^\circ$  side.

**S Curve:** Readings are about 2% line near .5. If greater accuracy is needed, bring **S** curve to meet point on its concave side rather than cover point in the range of .3 to .7.

**Radial Scale:** The radial scale is about .2% short compared to the nominal value of unity being  $5''$ .

**Width:** The width is about .01'' over the nominal  $2.5''$ . Lines drawn with a pencil along the edges will typically be spaced  $2.55''$  apart.

### Ordinate Addition

For long ordinates, align **A-** with the bottom of the ordinate and fix disk while rotating it until **A+** is at top of ordinate.

## CLOSED LOOP FUNCTION

$$R/C = E/C + B/C = 1/G + H$$

### Particular Case

$$R/C = \frac{s^2}{K} + \frac{(1+T's)}{(1+Ts)} = \frac{(1-s/r_1)(1-s/r_2)(1-s/r_3)}{(1+Ts)}$$

### General

$$C/R = \frac{(1-s/q_G)(1-s/p_H)}{\pi(1-s/r_i)} \left[ \frac{1}{(1/G + H)} \right]_{s=r_i}$$

## AMPLITUDE OF TRANSIENT TERMS

$$C(t) = \sum A_i e^{r_i t}; A_i = R(s) (C/R) (s-r_i) \Big]_{s=r_i}$$

For particular case above with step input  $R(s) = 1/s$

$$A_i = \frac{(1+Ts)(-r_i)}{s(1-s/r_2)(1-s/r_3)} \Big]_{s=r_i}$$

The amplitude is a product of vector lengths from the root as the pivot point.

If  $r_i$  is complex,  $A_i = A e^{j\theta}$

$$A_i e^{r_i t} + A_i^* e^{r_i^* t} = 2 \text{ Real Part } \{ A e^{j\theta} e^{at} e^{j\omega t} \} \\ = 2 e^{at} \cos(\omega t + \theta) \text{ for } r_i = a + j\omega$$

## LOCUS VS. ALMOST ANYTHING

$$Z + 1/Cs = 0; \text{ or } \frac{Z_0 \pi(1-s/q_i) Cs}{\pi(1-s/p_i)} = -1$$

**Z** is impedance looking into system from **C**. But **q** are roots for  $C = \infty$  (short circuit); **p** are roots for  $C = 0$  (open circuit). These sets of roots are known from original plot vs. loop gain. These roots plus an added zero at the origin as zeros and poles for plot vs. **C** as "gain".

This procedure is applicable to any parameter which need be used only once in the characteristic determinant of a system.

A root locus is determined by the roots for two finite values of **C**. Using  $C_1$  roots as poles, and  $C_2$  roots as zeros, the gain for the resultant plot is  $(C-C_1)/(C-C_2)$ .

A system can be analyzed by adding one freedom at a time which is particularly convenient for those who have a strong mental picture of the system.

### NICHOLS' CHART

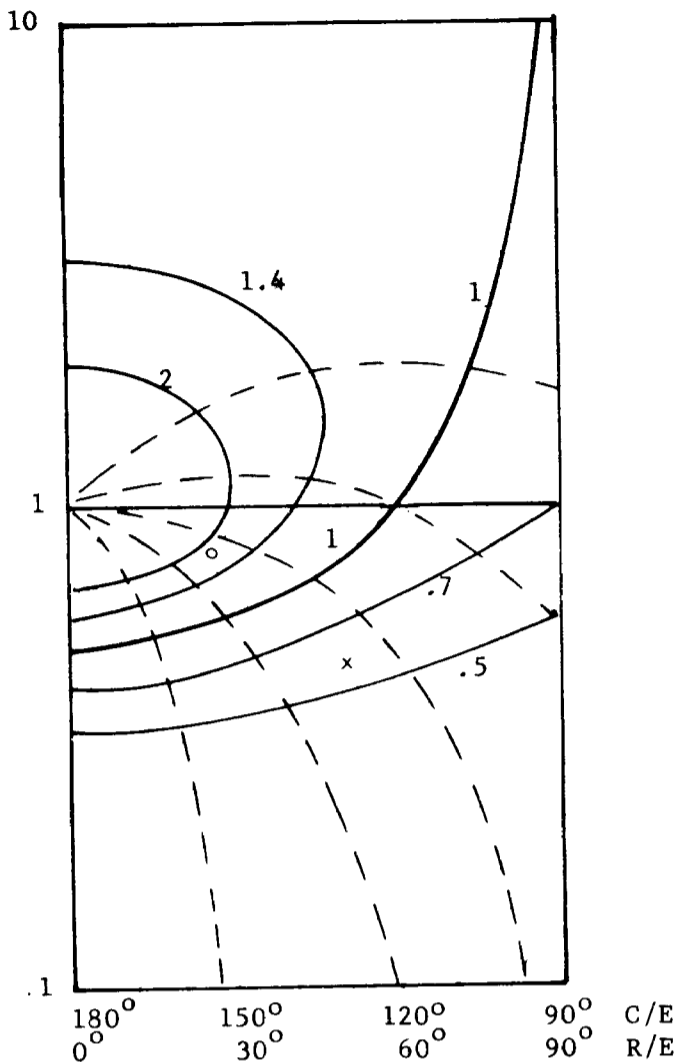

#### Instructions

- Place a clear sheet over the corrected Bode diagram and mark phase angle length as abscissae for a given frequency. For the same frequency, mark the log magnitude as ordinate. Repeat for enough pairs of lengths to obtain a smooth curve in the frequency region of unity loop gain.
- Overlay the sheet on the Nichols' chart above sliding vertically until tangency is reached with the curve for maximum resonance desired.
- "Reflect" the curve about the unity curve to obtain the closed loop characteristic. Any point is shifted along the phase curves across the unity gain curve by an equal number of gain curves. Thus point *o* is "reflected" to point *x*.
- Read off closed loop values using angle scale marked and the same magnitude scale.

Option: Mark lengths directly on the Bode plot axes.

### RIGHT TRIANGLE SOLUTION

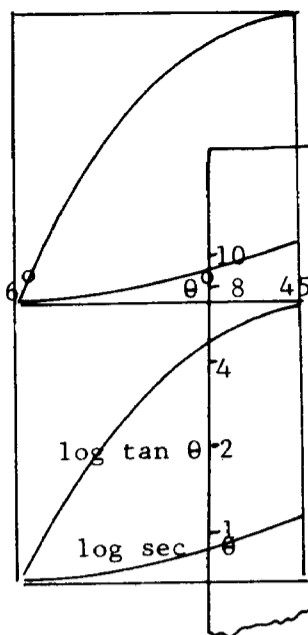

- Place the Spirule on "Trig-Graph" as shown on p. 16. Shifting it laterally changes from 6° to 45°; shifting vertically changes size.
- $\theta$  is read on the horizontal scale at the Spirule edge; **C**, **B**, and **A** are read on the Spirule scale at the curves or horizontal line as marked.
- Set any two values; which determine the triangle size and shape.
- Read the other two values. Keep the Spirule edge parallel to "Trig-Graph's" vertical lines. Two cycles of curves permit any size triangle to be solved with the one cycle of 5" log scale on the Spirule.

### CLOSING THE LOOP VECTORIALLY

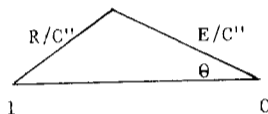

$R/C'' = 1 + E/C''$   
Given  $E/C''$  as  $C / 180^\circ - \theta$

- Aline Spirule on "Trig-Graph" for given values of **C** and  $\theta$ .

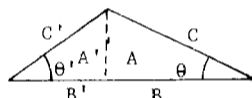

- Read values of **A** and **B**.
- Diagram at left shows that  $A' = A$ , and  $B' = 1 - B$ .

- Aline Spirule on "Trig-Graph" for  $A'$  and  $B'$ ; read **C'** and  $\theta'$ .

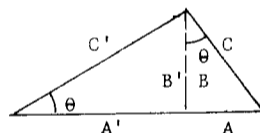

Given  $E/C''$  as  $C / 90^\circ + \theta$

- Same as (1) and (2) above.
- From this vector diagram  $B' = B$ ,  $A' = 1 - A$ .
- Same as (4) above.

Other combinations arise. The "Trig-Graph" angle is limited to 45° maximum; **A** is always less than **B**.

**Sum of Squares of Numbers:**  $X^2 = 5^2 + 4^2 + 12^2 + 1^2$

- Select 12 as **B** (largest number), and 5 as **A**.
- Read **C** as 13, shift 13 to **B**, and set **A** as 4.
- Read **C** as 13.6. (The effect of 1 is lost for the accuracy involved with this chart.)

The value given above is really the RSS (root sum square) value. For the RMS (root mean square) divide the RSS value by  $n^{1/2}$ , in which *n* is the number of terms in the sum.



# Spirule Instructions

by  
WALTER R. EVANS

## Contents

- \* 1 Symbols, Glossary, References
  - \* 2 Root-Locus Fundamentals
  - \* 3 Sketch Aids: Real Axis, Asymptotes, Quadratics
  - \* 4 Root-Loci Properties: Constant Sum, Conformal Map
  - \* 5 Addition of Angles (Arm Rotation from Disk)
  - \* 6 Multiplication of Lengths: Scale Factor Correction
  - \* 7 Slide Rule Usage, 'Db' Conversion
  - #10 Bode Plots:  $(1 + Ts) = 1$  or  $Ts$ ,  $90^\circ$  over two decades
  - 11 Correction for Bode Plots: **M** and **P** Curves ( $1 + Ts$ )
  - 9 Addition of Ordinates: **A+** and **A-** Curves
  - 8 Quadratic Curves: Log Amp. and Phase vs. Log  $w$
  - \* 12 Other Curves and Scales: **S/2**, **1/S**, Damping Ratio
  - \* 13 Closed Loop Function: Locus Vs. Almost Anything
  - 14 Nichols' Chart: Closed Loop from Bode Data
  - 15 Right Triangle Solution: Vector Sum
  - 16 "Trig-graph":  $\log \tan \theta$  and  $\log \sec \theta$  vs  $\theta$
- \* Applicable to root-locus  
#Suggested order of reading. (Page order is shifted to permit figures to be seen when reading associated text.)

## Symbols

- |   |                   |          |                   |
|---|-------------------|----------|-------------------|
| f | freq (cycles/sec) | <b>G</b> | Forward Function  |
| q | zero              | <b>H</b> | Feedback Function |
| p | pole              | <b>K</b> | Loop Gain         |
| r | root              | <b>P</b> | No. of Poles      |
| s | Laplace variable  | <b>Q</b> | No. of Zeros      |
| w | freq (rad/sec)    | <b>T</b> | Time Constant     |

(1) Reference number for text and figures

## Glossary

**SP** (Starting Position) — The **R** line is at  $0^\circ$  on the disk which also puts the  $x1$  arrow of disk at 1 on arm scale.

**Fix Disk** — Press disk against plot with the right index finger; motion of arm then changes readings between arm and disk. Otherwise the disk is free.

**Bode Plot** — Plot of log mag. and phase vs. log  $w$ .

**Nichols' Chart** — Conversion chart from open loop to closed Loop using log mag. and phase.

**Break Frequency:** The frequency at which the straight line asymptotes on the Bode plot change slope.

**Quadratic:** A function of the form  $1 + 2bs/w + s^2/w^2$ , which arises for any system having energy interchange such as kinetic and potential in a spring-mass system.

**Vector:** A complex number identified by its magnitude and angle for convenience in taking products.

**Damping Ratio:** The ratio of the real part of the root to its magnitude. It is thus a measure of the decay rate per cycle of natural oscillation.

## References

- W. R. Evans — "Control System Dynamics," McGraw Hill, 1954
- J. G. Truxal — "Control System Synthesis," McGraw Hill, 1955
- C. H. Wilts — "Principles of Feedback Control," Addison-Wesley, 1960

Copyright 1965: The Spirule Company  
9728 El Venado Drive  
Whittier, California 90603, U.S.A.

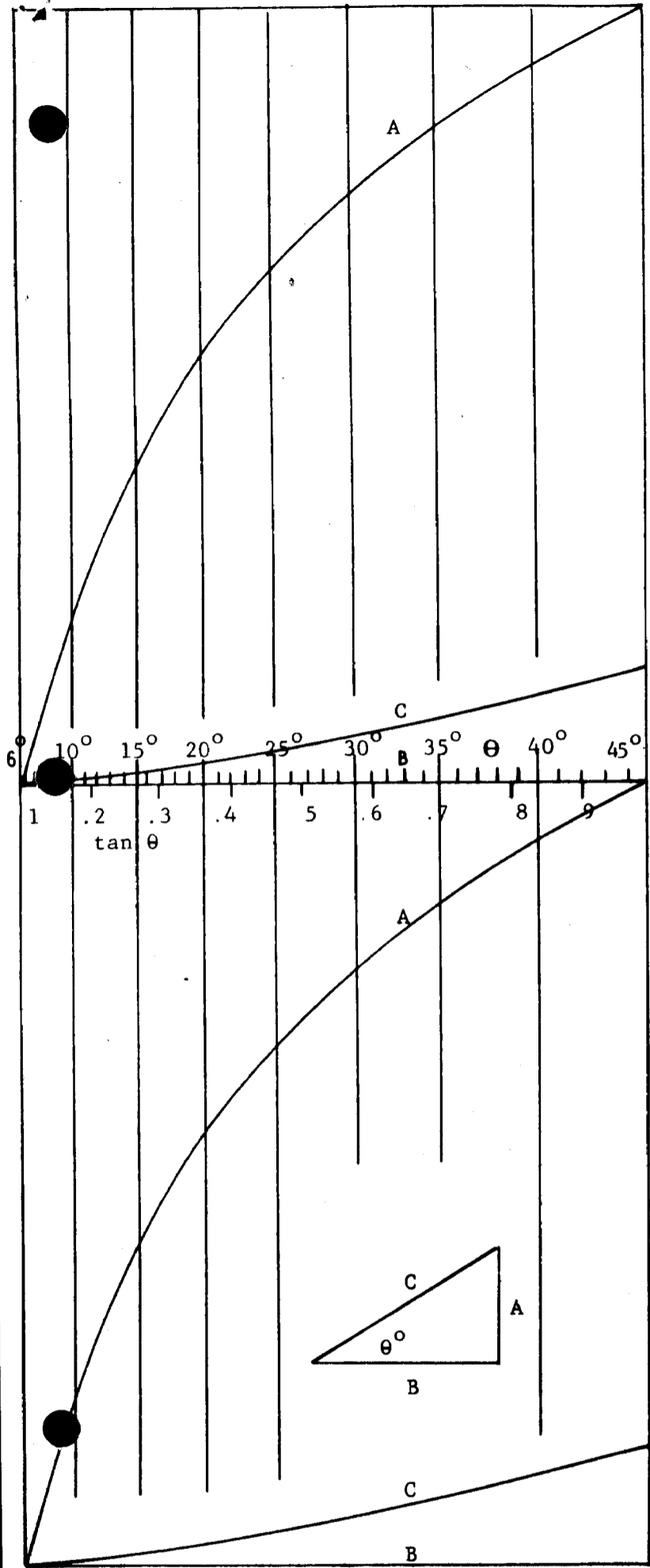

QUADRATIC CURVES

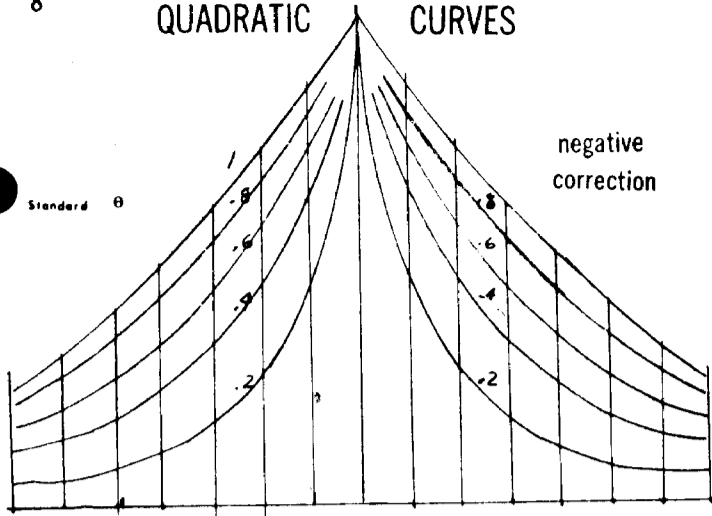

Standard Log. Mag.

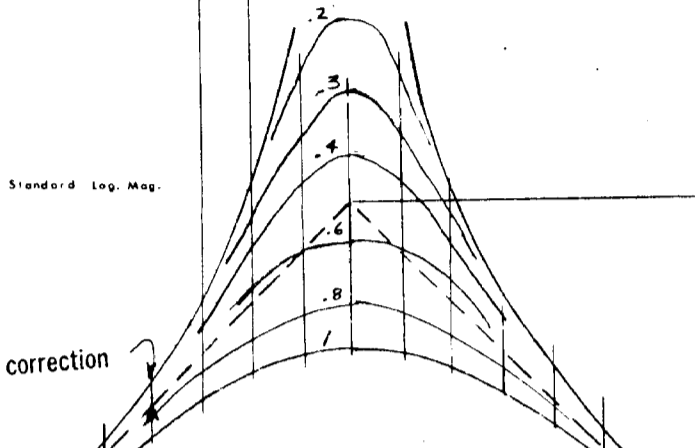

Modified B

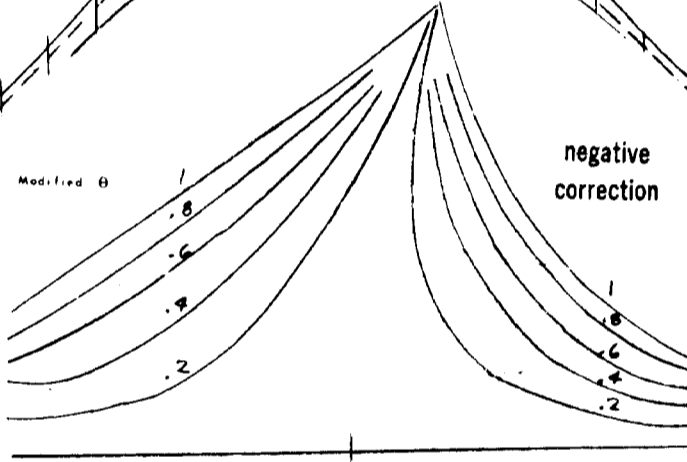

Modified Log. Mag.

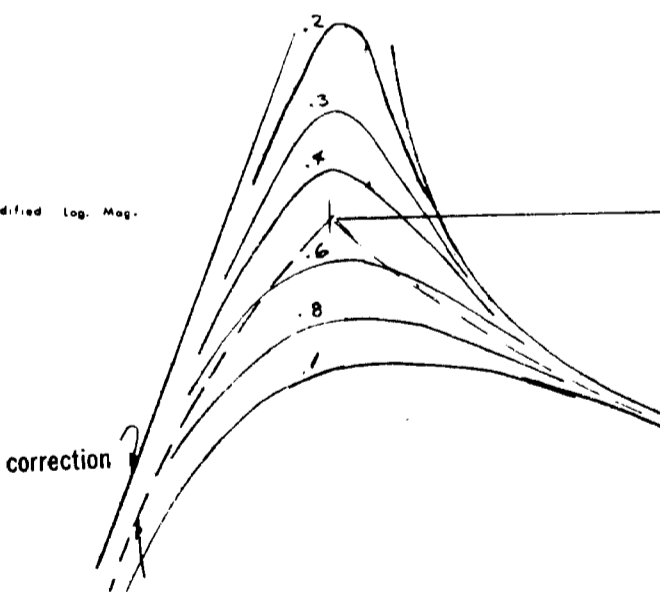

ADDITION OF ORDINATES

Option for Quadratic Correction (No Tracing)

1) Mark poles and zeros on the frosted plastic strip enclosed. (Mark damping ratio at each.)

(2) Fix strip on this line with w to be checked at

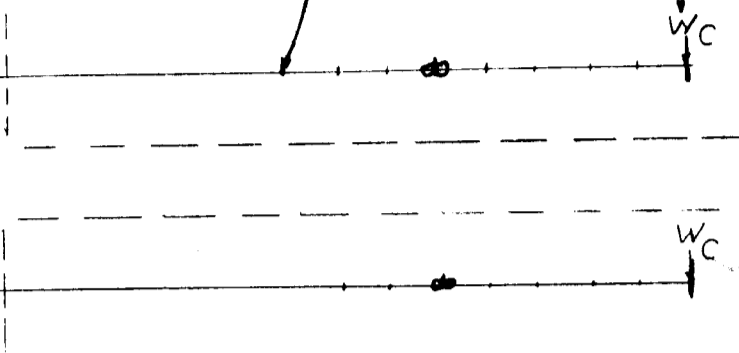

3) Shift pivot to the zero; fix disk while rotating A+ curve from the ordinate for the q quadratic back to the base line.

4) Shift pivot to pole; fix disk while rotating A+ curve to ordinate of curve for the p quadratic.

5) Read net correction on disk as before ( $10^\circ = 1''$ ).

Modified Quadratic Curves

1) Mark poles and zeros on the frosted plastic strip enclosed. (Mark damping ratio at each.)

(2) Fix strip on arm along R line with w to be checked at the apex of the A+, A- curves.

(3) Aline Spirule with pivot here

4) Fix disk while rotating arm until a pole is on the correction curve for its damping ratio.

5) For a zero, fix disk while rotating q from a curve to base line.

6) Read angle on disk at R line.

7) Plot correction using .2 on radial scale as  $10^\circ$  of disk reading.

8) Repeat steps 2-7 for enough points to determine the curve of the transfer function.

### BODE PLOTS

#### Approximation of $1 + j\omega T$

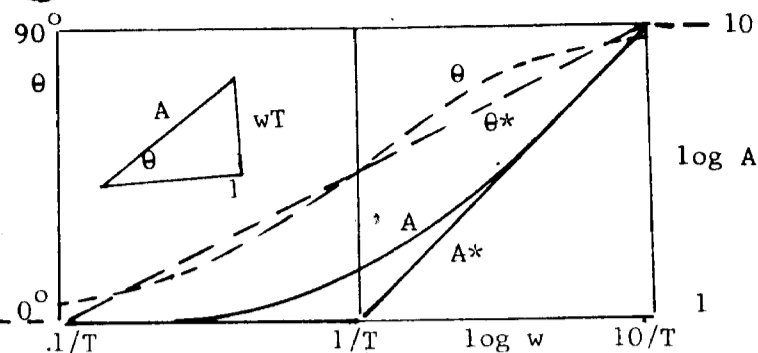

$A^*$  (approximation) = 1 for  $\omega T < 1$ , =  $\omega T$  for  $\omega T > 1$   
 $\theta^*$  (approximation) =  $45^\circ (1 + \log_{10} \omega T)$  for  $.1 < \omega T < 10$

#### Example Using $(1 + Ts)$ Approximations

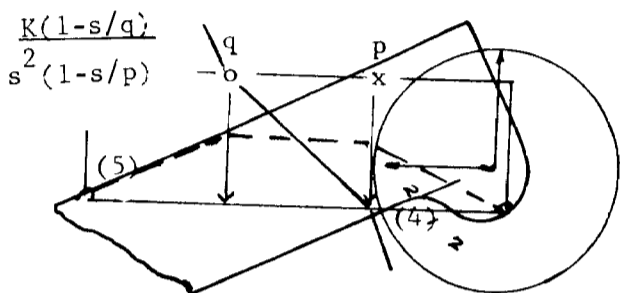

- (1) Mark the zeros and poles along the log  $\omega$  axis.
- (2) Mark half-zero and half-pole points on a parallel axis to denote break points for angle plot.
- (3) Draw straight line plots starting from known ordinate at left and working to the right using proper slopes between break frequencies.
- (4) For the 1/2 slope, set edge of arm at 2 on scale as shown; the other 2 is for a slope of 2.
- (5) Hold a pencil at starting point to serve as pivot.
- (6) Pivot arm about pencil until arrows on disk are square with plot. Draw line along edge to next break.

#### Quadratic Example:

$$\frac{K(1-s/p)(1-s/q^*)}{s(1-s/p)(1-s/p^*)}$$

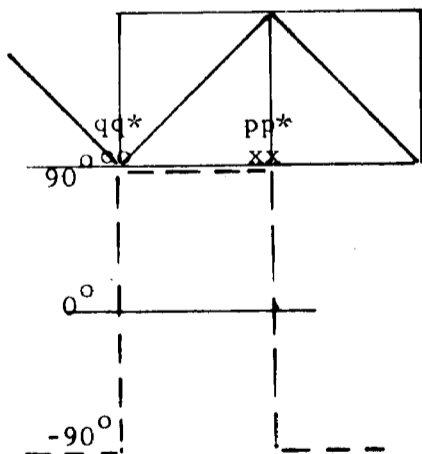

### CORRECTION TO $(1 + Ts)$ BODE PLOTS

#### Magnitude (M Curve)

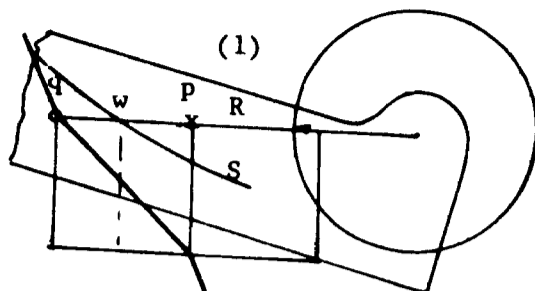

- (1) With disk at SP, RS intersection at the frequency  $\omega$  being checked, and R horizontal, fix pivot as shown.

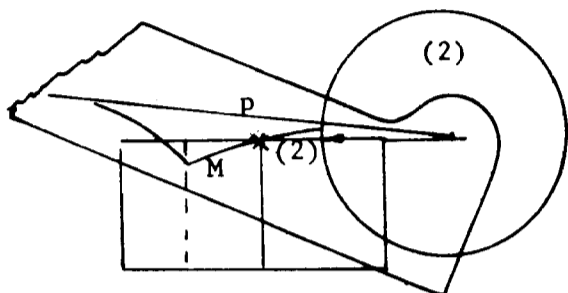

- (2) Fix disk while rotating M curve to pole.
- (3) Aline M with q, then fix disk while returning to level. The option, for net angle of q and p, is to fix disk while rotating M curve q to p.
- (4) Read the correction on arm scale at x1 arrow.
- (5) Plot correction from the straight line plot using  $2\frac{1}{2}$ " log scale on edge of Spirule.

#### Angle Correction (P Curve)

- 1-4) Same as for Magnitude section except P curve is used instead of M curve.
- 5) Read the correction angle on disk at R line.
- 6) Plot correction from the Bode plot using the angle scale at the end of the arm.

#### Quadratic Correction

The curves on p. 8 and the instructions on p. 9 are an evolution from tracing templates and adding ordinates to the equivalent of M and P curves for quadratics. Instructions on p. 8 are limited to details of placement of curves and Spirule. Two possibilities are described, but the latter is recommended as the most efficient.

The modified curves gives the correction as an angle as a function of log  $\omega$  separations between the frequency being checked  $\omega$ , and the poles or zeros.

## OTHER CURVES AND SCALES

**Logarithmic Spiral Curve,  $\theta/90 = \log_{10} A/5''$** 

The angle between **R** and **S** varies as the log of the length **A** to the **S** curve. A  $90^\circ$  change corresponds to a length ratio of 1/10, unity is  $5''$  for  $\theta = 0^\circ$ .

The scale factor correction makes the results independent of the scale of the graph paper used.

$1/S$  is a reflection of the **S** curved about the edge. If the edge is used as a reference instead of **R**, fix disk while rotating from  $1/S$  to edge to get same angle and sense as from edge to missing curve.

$S/2$  has  $1/2$  the angle from **R** as the missing part of the **S** curve. Rotate twice between **R** and  $S/2$ .

**Damping Ratio Scale**

Fix the pivot at origin with  $180^\circ$  of the disk along the negative real axis of the plot. Aline the edge of the arm at the damping ratio desired and draw a line on the plot as possible criterion for root location along a locus.

**Scale of Graph Paper**

A quadrille tablet with 4 lines to the inch is the intended paper for plots. This paper gives 10 lines in the  $2\frac{1}{2}''$  width of the Spirule arm. Such tablets are widely available and relatively inexpensive.

**Additional Curves**

The purpose of any curve is to convert any quantity of interest to an angle. Apply frosted mending tape to the arm to permit any additional curves to be added in pencil. (The given curves are printed on the middle layer of laminated plastic.)

The disk may slip with respect to the arm when working on a soft pad of paper. Work on a single sheet on a hard surface or return Spirule for a free adjustment.

The handle has been added for easier control of the arm and shorter hand motions.

**Accuracy**

**Angle:** The protractor scale is accurate despite the apparent eccentricity suggested by index lines being longer on the  $180^\circ$  side than on the  $0^\circ$  side.

**S Curve:** Readings are about 2% line near .5. If greater accuracy is needed, bring **S** curve to meet point on its concave side rather than cover point in the range of .3 to .7.

**Radial Scale:** The radial scale is about .2% short compared to the nominal value of unity being  $5''$ .

**Width:** The width is about .01" over the nominal  $2.5''$ . Lines drawn with a pencil along the edges will typically be spaced  $2.55''$  apart.

**Ordinate Addition**

For long ordinates, aline **A-** with the bottom of the ordinate and fix disk while rotating it until **A+** is at top of ordinate.

## CLOSED LOOP FUNCTION

$$R/C = E/C + B/C = 1/G + H$$

**Particular Case**

$$R/C = \frac{s^2}{K} + \frac{(1+T's)}{(1+Ts)} = \frac{(1-s/r_1)(1-s/r_2)(1-s/r_3)}{(1+Ts)}$$

**General**

$$C/R = \frac{(1-s/q_1)(1-s/p_1)}{\pi(1-s/r_1)} \left[ \frac{1}{(1/G + H)} \right]_{s=r_1}$$

## AMPLITUDE OF TRANSIENT TERMS

$$C(t) = \sum A_i e^{r_i t}; A_i = R(s) (C/R) (s-r_i) \Big]_{s=r_i}$$

For particular case above with step input  $R(s) = 1/s$

$$A_i = \frac{(1+Ts)(-r_i)}{s(1-s/r_2)(1-s/r_3)} \Big]_{s=r_i}$$

The amplitude is a product of vector lengths from the root as the pivot point.

If  $r_i$  is complex,  $A_i = A e^{j\theta}$

$$A_i e^{r_i t} + A_i^* e^{r_i^* t} = 2 \text{ Real Part } \left\{ A e^{j\theta} e^{at} e^{j\omega t} \right\} \\ = 2 e^{at} \cos(\omega t + \theta) \text{ for } r_i = a + j\omega$$

## LOCUS VS. ALMOST ANYTHING

$$Z + 1/Cs = 0; \text{ or } \frac{Z_0 \pi(1-s/q_i) Cs}{\pi(1-s/p_i)} = -1$$

**Z** is impedance looking into system from **C**. But **q** are roots for  $C = \infty$  (short circuit); **p** are roots for  $C = 0$  (open circuit). These sets of roots are known from original plot vs. loop gain. These roots plus an added zero at the origin as zeros and poles for plot vs. **C** as "gain".

This procedure is applicable to any parameter which need be used only once in the characteristic determinant of a system.

A root locus is determined by the roots for two finite values of **C**. Using  $C_1$  roots as poles, and  $C_2$  roots as zeros, the gain for the resultant plot is  $(C - C_1)/(C - C_2)$ .

A system can be analyzed by adding one freedom at a time which is particularly convenient for those who have a strong mental picture of the system.

# ROOT-LOCUS FUNDAMENTALS

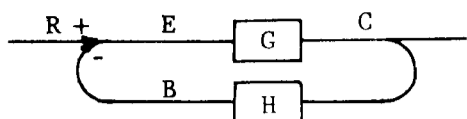

Characteristic Equation:  $R = 0$ , or  $E = -B$

Thus,  $(B/E) = GH$  must  $= -1 = 1 / \underline{180^\circ}$

Typically  $GH = \frac{K'(s-q)}{s^2(s-p)}$

## Root-Locus

$$2\theta + \theta_1 - \phi_1 = 180^\circ$$

$$K' = \frac{|s|^2 |s-p|}{|s-q|}$$

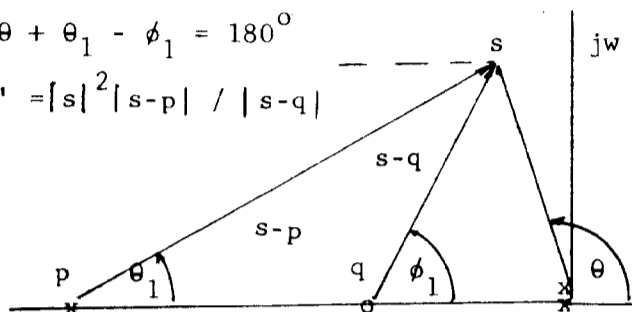

Poles and zeros of the **GH** function determine locus of roots of  $GH = -1$  as  $K'$  is increased from 0 to infinity.

A sketch of root-locus is made first using special intervals (p. 3). In the region of interest, a trial  $s$  point is chosen and the net angle is measured with the Spirule. The locus is then interpolated between trial points. For a desired root along the locus, gain is computed as product of vector lengths (p. 6).

For cases in which  $s$  covers more than 10/1 range, a "ballpark" plot determines phase shift pattern in the "infield" due to "outfield" poles.

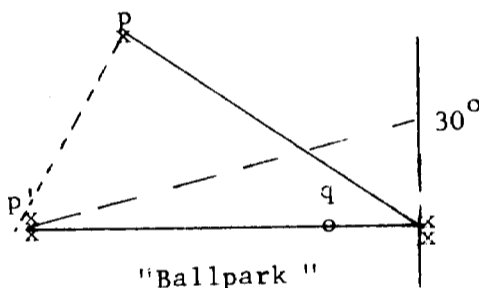

"Ballpark"

The pole  $p'$  produces the same phase shift at low  $w$  as  $p$  or  $p^*$ .

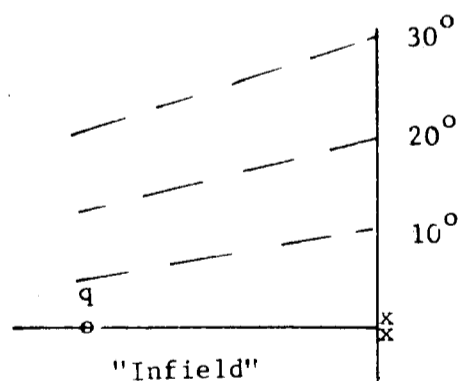

"Infield"

# SKETCH AIDS FOR ROOT-LOCUS PLOTS

$$\frac{K'}{s(s-p_1)(s-p_2)} = -1$$

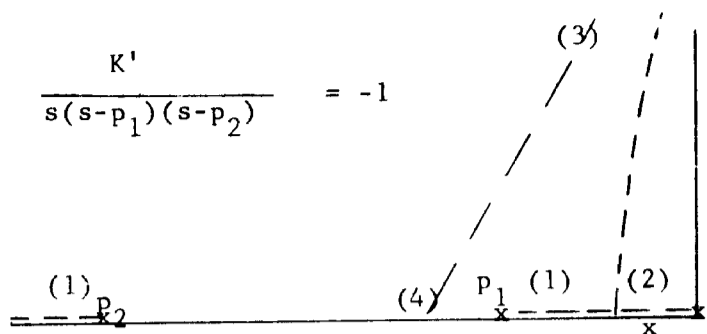

- (1) **Real Axis Intervals** — The real axis intervals occur wherever the total number of zeros and poles which lie to the right is odd.
- (2) **Breakaway Point:**  $1/x = 1/(x-p_1) + 1/(x-p_2)$
- (3) **Asymptotes:**  $(180^\circ + n360^\circ)/(P-Q)$
- (4) **Centroid of Asymptotes:**  
 $C = (\text{Sum of } p - \text{Sum of } q)/(P-Q)$
- 5) **Symmetry about the real axis** exists for conjugate zeros and poles and real gain values.
- 6) Roots move from poles to asymptotes or zeros as gain  $K'$  increases from zero to  $\infty$ .

## Quadratic

$$\frac{K'(s-q)}{s^2} = -1$$

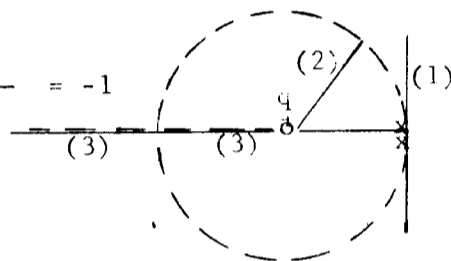

- (1) The locus breaks away from double pole at  $90^\circ$ .
- (2) The locus is circle about zero  $q$  as center.
- (3) The locus approaches  $q$  or  $-\infty$  as  $K'$  increases.

## Initial Direction From Complex Pole or Zero

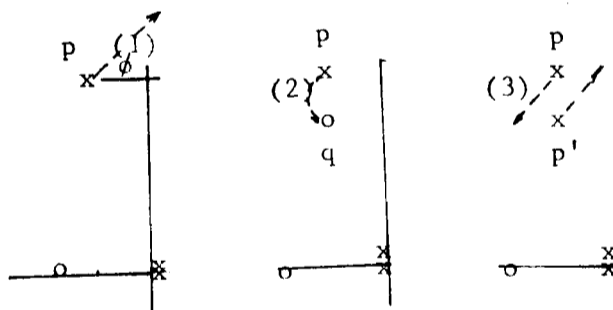

- (1) Select  $p$  to be the trial  $s$  point. Find sum of angles for all other zeros and poles; then make the angle  $\phi$  from pole bring the total angle to  $180^\circ$ .
- (2) A zero  $q$  close to  $p$  makes a circle arc locus between  $p$  and  $q$ .
- (3) A pole  $p'$  reverses the  $p$  branch, but its branch starts along original  $p$  branch direction.

## PROPERTIES OF ROOT-LOCI

### Centroid of Roots Constant

For a transfer function having  $P-Q \geq 2$ , the vector sum of the roots is constant.

### Substitution of Poles for Roots

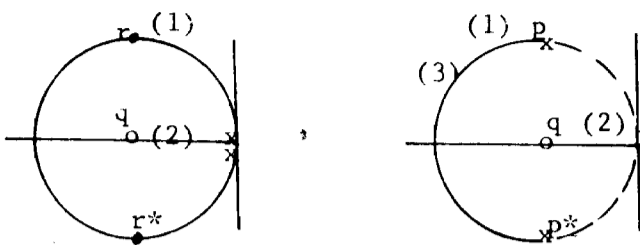

- (1) Replace roots at given  $K_1$  with new poles  $p$  and  $p^*$ .
- (2) Retain zero  $q$ ; continue locus along original path.
- (3) The gain in new plot is the increase  $\Delta K$  over  $K_1$ .

### Nearly Equal Roots

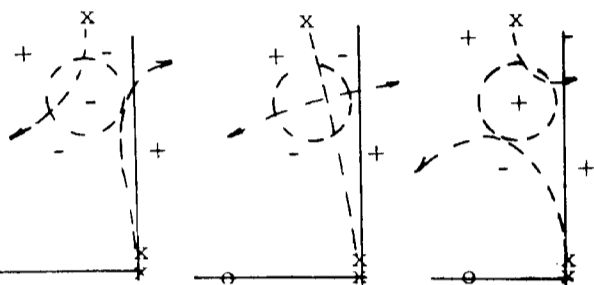

"Right Turn"      "Loci Meet"      "Left Turn"

Angle sums in the dotted circle area are all nearly  $180^\circ$ . A slight shift of the zero will change the "loci meet" plot to the "left turn" or "right turn" plot. Measure the angle near center of circle; if  $-$  deviation from  $180^\circ$ , a right turn plot results. If  $+$  deviation, a left turn. Neither transient response nor frequency response is critical to the choice of root locations in such cases if the roots are not close to the  $j$  axis.

### Force Analogy

The locus is in direction of net vector force acting on a particle which is repelled from poles and attracted to zeros inversely proportional to distance.

### Conformal Mapping

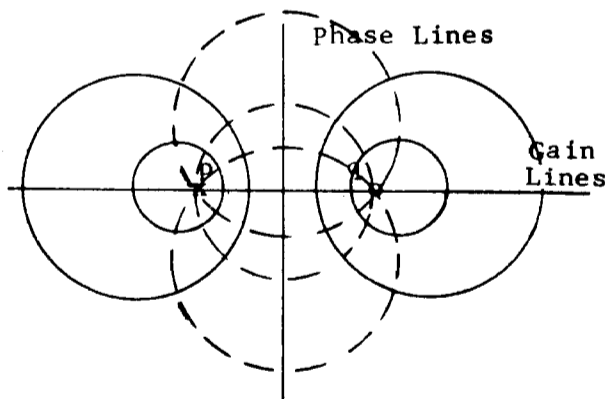

## ADDITION OF ANGLES

### Starting Position

### After First Angle

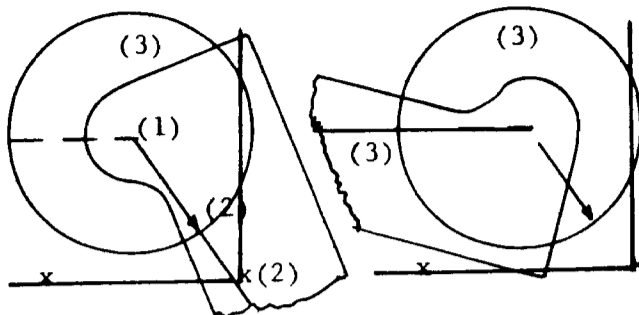

- (1) Center pivot at trial  $s$  point; fix it with right thumb.
- (2) With disk at  $SP$ , align  $R$  with pole at origin.
- (3) Fix disk while rotating  $R$  to the horizontal.
- (4) Release disk; repeat rotations for other poles.
- (5) Read angle of disk at the  $R$  line.
- (6) Mark error on plot ( $5^\circ$  for  $185^\circ$  reading).
- (7) Interpolate locus between marked points.

### Reverse Rotation for Zeros

For a zero, fix disk while rotating  $R$  from horizontal to the zero. For net angle of zero and pole, fix disk while rotating  $R$  from pole to zero.

### Change in Angle Sum for Change in Trial $s$ Point

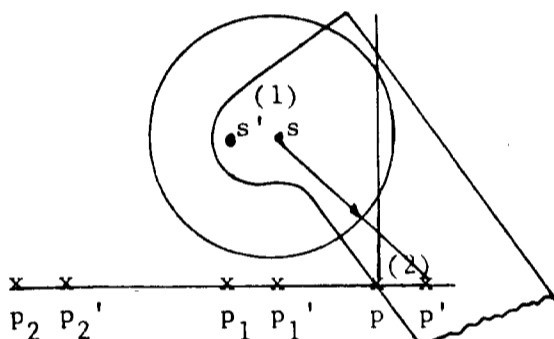

- (1) A new trial  $s$  point at  $s'$  involves small angle changes from previously measured values.
- (2) Leave pivot at  $s$ , but consider all poles to be shifted 1 square of graph paper to the right as marked by primed poles.
- (3) Fix disk while rotating arm from  $p'$  to  $p$  for all poles. For zeros, rotate from  $q$  to  $q'$ .
- (4) Read net angle change equivalent to pivot at  $s'$  instead of  $s$ .
- (5) Add change to previous value marked at  $s$  and mark the new value at  $s'$ .

### Breakaway Point from Real Axis

Select point just above real axis and carry out rotations in the usual way.

### Option

Use  $j\omega$  axis rather than a horizontal line when convenient. Angle reading for point on locus should then be  $(P-Q-2) 90^\circ$ .

### MULTIPLICATION OF LENGTHS

Starting Position

After First Pole

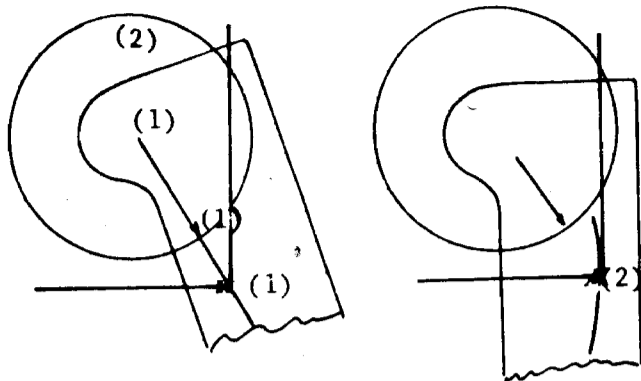

- (1) Center the pivot at *s* point, set disk at SP, aline **R** with the pole at the origin.
- (2) Fix disk while rotating arm until **S** is on pole.
- (3) Release disk, repeat steps (1), (2) for other poles.
- (4) For zeros, fix disk while rotating from **S** to **R**.
- (5) Read product on the arm scale at the disk arrow. (Reading of .4 with x.1 arrow means .04.)
- (6) Scale factor correction (next section) is carried out before above operations at *s* point.

#### Scale Factor Correction

$$\frac{K' (s+5)}{s (s+10) (s+30)} = -1$$

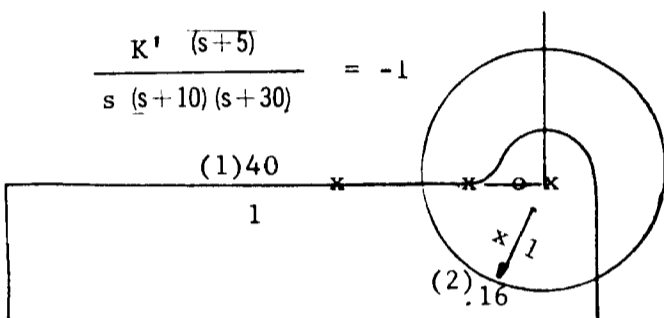

- (1) Read plot value  $L_1 = 40$  at unity (5") on Spirule.
- (2) Note  $P - Q = 2$ ; therefore correction  $(L_1)^{P-Q} = 1600$ . Set .16 at x1 arrow. (.16 is the same as 1600, 1 revolution = 10,000.)
- (3) Put a pencil mark on the disk at edge of arm to record starting point for any subsequent *s* point.
- (4) Shift to trial *s* point and carry out usual rotations starting from the marked position of disk.
- (5) Read  $K'$  on arm scale already corrected.

$$\frac{K(1+s/5)}{s(1+s/10)(1+s/30)} = -1$$

$$K = \frac{s(s+10)(s+30)}{(s+5)} \frac{5}{10 \cdot 30}$$

The correction can be made by multiplying by 1600 as before and then by 5/10 30.  $K$  is the value of gain usually used, not  $K'$  as in the previous form.

An alternate procedure bypasses the scale factor correction for all points except pole at the origin.

- (1) Place the pivot at the origin and rotate for **R** to **S** for poles at 10 and 30, and from **S** to **R** for the zero at 5.
- (2) Read angle on disk and set the negative angle. (Read 15° and set 345° in this case.)
- (3) Multiply by 40 and mark disk at edge of arm.
- (4) Shift pivot to trial *s* point, rotate as usual, read  $K$  on arm scale already corrected.

### USE AS A SLIDE RULE

Example:  $.4 \times .3 \times .2$

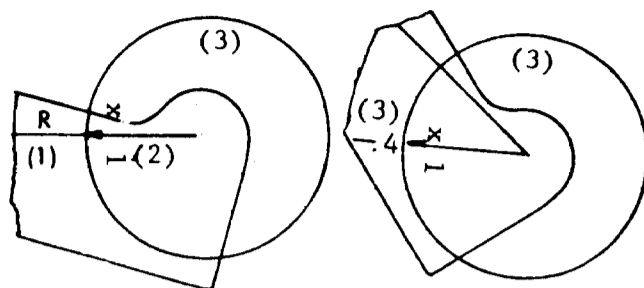

- (1) Draw straight line to serve as a crosshair.
- (2) With disk at SP, and **R** on the line, fix pivot.
- (3) Fix disk while rotating arm until **.4** is on line.
- (4) Release disk and return **R** to the line.
- (5) Repeat steps (3) and (4) for **.3** and **.2**.
- (6) Read **.24** at x.1 arrow giving **.024** as the result.

Example:  $800 \times .3 / .4 = .8 \times .3 / .4 \times 10^3$

- 1) Carry out steps 1-4 for **.8** and **.3**.
- 2) With the disk free, aline **.4** on the crosshair.
- 3) Fix disk while rotating arm until **R** is on the line.
- 4) Read result of **.6** at x1 arrow  $\times 10^3 = 600$ .

**Option:** The net result of the ratio  $.3/.4$  can be obtained by fixing disk while rotating arm from **.4** on the line to **.3** on the line.

**Option:**  $800 \times .3 / .4 = 8 \times 3 / 4 \times 10^2$

The steps are the same as above except  $R'$  is used instead of **R**. Ignore the decimal points on arm scale, treating the scale as 1 to 10 instead of .1 to 1.

#### "Db" Conversion

Set the x10 arrow on number on arm scale, read log value on disk at **R** line (again ignoring decimal point), and multiply log by 20 for "Db" value. Divide "Db" by 20, set it on log scale, and read value on arm scale.

#### Approximation for $(1+x)^n$

$$\log_{10} (1+x)^n = n (\log_{10} e) \log (1+x) = n(1/2.3) (x)$$

$$N = (1.03)^{20}; \log_{10} N = 20(.03)/2.3 = .26; N = 1.85$$

$$\text{Actually } \log (1+x) = x - 1/2(x)^2 + (1/3)x^3 - \dots$$

$$N = (1.1)^{20}; \log_{10} N = (.1 - .005)20/2.3 = .414; N = 2.6$$

#### Mental Log Scale

N	1.25	2.0	3.2	5.0	8.0
		1.6	2.5	4.0	6.4
$\log_{10} N$	.1	.2	.3	.4	.5
		.6	.7	.8	.9
					1

### NICHOLS' CHART

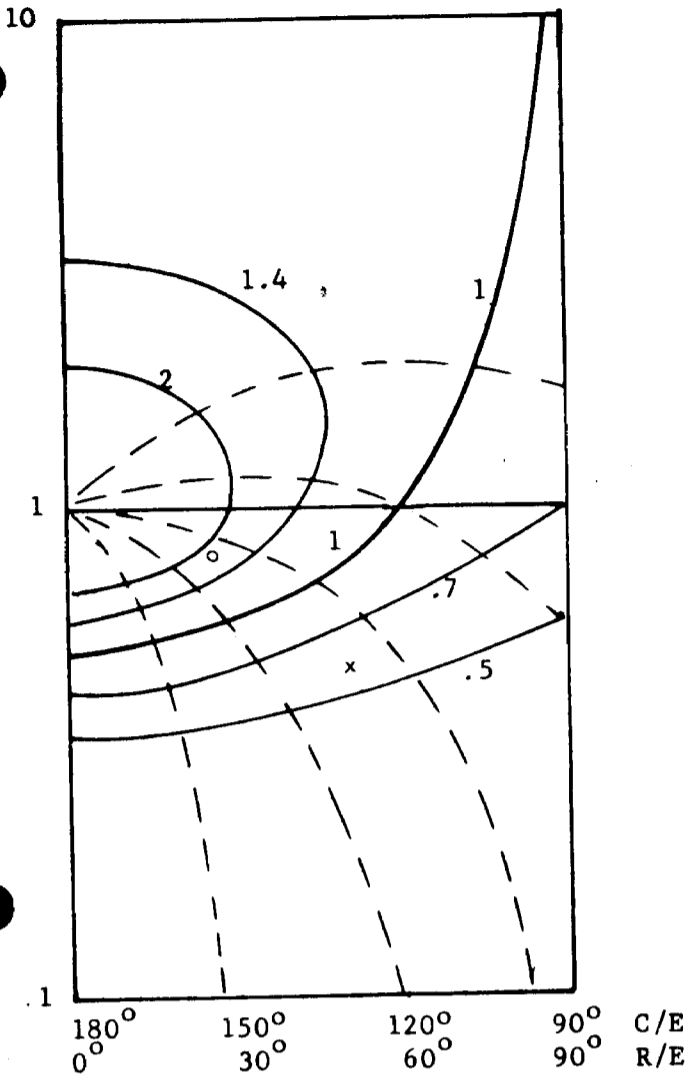

#### Instructions

- (1) Place a clear sheet over the corrected Bode diagram and mark phase angle length as abscissae for a given frequency. For the same frequency, mark the log. magnitude as ordinate. Repeat for enough pairs of lengths to obtain a smooth curve in the frequency region of unity loop gain.
- (2) Overlay the sheet on the Nichols' chart above sliding vertically until tangency is reached with the curve for maximum resonance desired.
- (3) "Reflect" the curve about the unity curve to obtain the closed loop characteristic. Any point is shifted along the phase curves across the unity gain curve by an equal number of gain curves. Thus point *o* is "reflected" to point *x*.
- (4) Read off closed loop values using angle scale marked and the same magnitude scale.

Option: Mark lengths directly on the Bode plot axes.

### RIGHT TRIANGLE SOLUTION

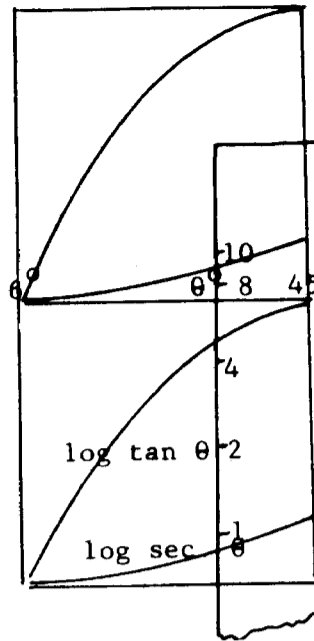

- (1) Place the Spirule on "Trig-Graph" as shown on p. 16. Shifting it laterally changes from 6° to 45°; shifting vertically changes size.
- (2)  $\theta$  is read on the horizontal scale at the Spirule edge; **C**, **B**, and **A** are read on the Spirule scale at the curves or horizontal line as marked.
- (3) Set any two values; which determine the triangle size and shape.
- (4) Read the other two values. Keep the Spirule edge parallel to "Trig-Graph's" vertical lines. Two cycles of curves permit any size triangle to be solved with the one cycle of 5" log scale on the Spirule.

### CLOSING THE LOOP VECTORIALLY

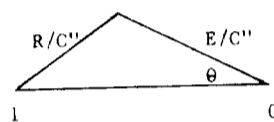

$R/C'' = 1 + E/C''$   
 Given  $E/C''$  as  $C / 180^\circ - \theta$

- (1) Aline Spirule on "Trig-Graph" for given values of **C** and  $\theta$ .
- (2) Read values of **A** and **B**.
- (3) Diagram at left shows that  $A' = A$ , and  $B' = 1 - B$ .
- (4) Aline Spirule on "Trig-Graph" for  $A'$  and  $B'$ ; read  $C'$  and  $\theta'$ .

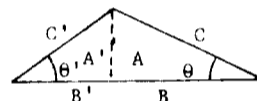

Given  $E/C''$  as  $C / 90^\circ + \theta$

- (1) Same as (1) and (2) above.
- (2) From this vector diagram  $B' = B$ ,  $A' = 1 - A$ .
- (3) Same as (4) above.

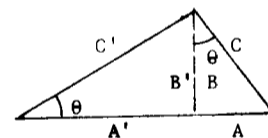

Other combinations arise. The "Trig-Graph" angle is limited to 45° maximum; **A** is always less than **B**.

**Sum of Squares of Numbers:**  $X^2 = 5^2 + 4^2 + 12^2 + 1^2$

- (1) Select 12 as **B** (largest number), and 5 as **A**.
- (2) Read **C** as 13, shift 13 to **B**, and set **A** as 4.
- (3) Read **C** as 13.6. (The effect of 1 is lost for the accuracy involved with this chart.)

The value given above is really the RSS (root sum square) value. For the RMS (root mean square) divide the RSS value by  $n^{1/2}$ , in which *n* is the number of terms in the sum.



